

## PRIMA INDUSTRIE®

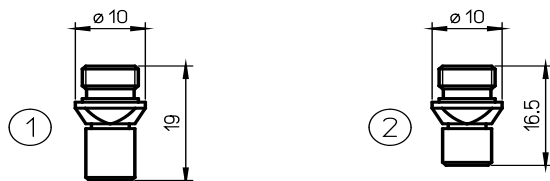

POS	obj.číslo	originál kód	popis
1	PR331-4102X	490.76.102	PRIMA I.® tryska Ø 0.3 cylindrická mosazná
	PR331-0001BX		PRIMA I.® tryska Ø 1.0 mosazná cylindrická
	PR331-0001X		PRIMA I.® tryska Ø 1.0 mēdēná cylindrická
	PR331-0002X		PRIMA I.® tryska Ø 1.2 mēdēná cylindrická
	PR331-3321BX	485.73.321	PRIMA I.® tryska Ø 1.5 mosazná cylindrická
	PR331-3321CX		PRIMA I.® tryska Ø 1.5 mēdēná cylindrická
	PR331-0003X		PRIMA I.® tryska Ø 1.7 mēdēná cylindrická
	PR331-3322BX	485.73.322	PRIMA I.® tryska Ø 2.0 mosazná cylindrická
	PR331-322CX		PRIMA I.® tryska Ø 2.0 mēdēná cylindrická
	PR331-3323BX	485.73.323	PRIMA I.® tryska Ø 2.5 mosazná cylindrická
	PR331-3323CX		PRIMA I.® tryska Ø 2.5 mēdēná cylindrická
	PR331-3324BX	485.73.324	PRIMA I.® tryska Ø 3.0 mosazná cylindrická
	PR331-3324X		PRIMA I.® tryska Ø 3.0 mēdēná cylindrická
	PR331-0001CPX		PRIMA I.® tryska Ø 1.0 chrom
	PR331-0002CPX		PRIMA I.® tryska Ø 1.2 chrom
	PR331-0321CCPX	485.73.421	PRIMA I.® tryska Ø 1.5 chrom
	PR331-0003CPX		PRIMA I.® tryska Ø 1.7 chrom
	PR331-322CCPX	485.73.422	PRIMA I.® tryska Ø 2.0 chrom
	PR331-3323CCPX	485.73.423	PRIMA I.® tryska Ø 2.5 chrom
	PR331-3324CPX	485.73.424	PRIMA I.® tryska Ø 3.0 chrom
2	PR331-0302X	490.1N.302	PRIMA I.® tryska Ø 2.5 mosazná krátká

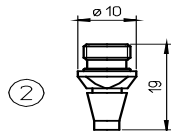
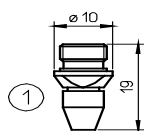

POS	obj.číslo	originál kód	popis
	<a href="#">PR393-0001X</a>		PRIMA I.® tryska Ø 0.3
	<a href="#">PR393-0002X</a>		PRIMA I.® tryska Ø 1.0
	<a href="#">PR393-0003X</a>		PRIMA I.® tryska Ø 1.2
	<a href="#">PR393-0004X</a>		PRIMA I.® tryska Ø 1.5
	<a href="#">PR398-0005X</a>		PRIMA I.® tryska Ø 1.7
	<a href="#">PR393-0006X</a>		PRIMA I.® tryska Ø 2.0
	<a href="#">PR393-0007X</a>		PRIMA I.® tryska Ø 2.5
	<a href="#">PR393-0008X</a>		PRIMA I.® tryska Ø 3.0
	<a href="#">PR393-3455CPX</a>	<a href="#">485.73.455</a>	PRIMA I.® tryska Ø 0.3 chrom CON-CYL
	<a href="#">PR393-3451CPX</a>	<a href="#">485.73.451</a>	PRIMA I.® tryska Ø 1.5 chrom CON-CYL
	<a href="#">PR393-3452CPX</a>	<a href="#">485.73.452</a>	PRIMA I.® tryska Ø 2.0 chrom CON-CYL
	<a href="#">PR393-3453CPX</a>	<a href="#">485.73.453</a>	PRIMA I.® tryska Ø 2.5 chrom CON-CYL

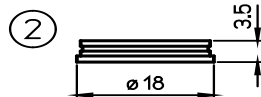
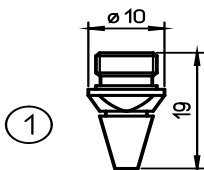

POS	obj.číslo	originál kód	popis
	<a href="#">PR357-0001X</a>	<a href="#">490.76.103</a>	PRIMA I.® tryska Ø 0.3 konická mosazná
	<a href="#">PR357-0002X</a>		PRIMA I.® tryska Ø 1.0 konická měděná
	<a href="#">PR357-0003X</a>		PRIMA I.® tryska Ø 1.2 konická měděná
	<a href="#">PR357-331BX</a>	<a href="#">485.73.331</a>	PRIMA I.® tryska Ø 1.5 konická mosazná
	<a href="#">PR357-331CX</a>		PRIMA I.® tryska Ø 1.5 konická měděná
	<a href="#">PR357-0004X</a>		PRIMA I.® tryska Ø 1.7 konická měděná
	<a href="#">PR357-333BX</a>	<a href="#">485.73.333</a>	PRIMA I.® tryska Ø 2.0 konická mosazná
	<a href="#">PR357-333CX</a>		PRIMA I.® tryska Ø 2.0 konická měděná
	<a href="#">PR357-0005X</a>		PRIMA I.® tryska Ø 2.5 konická mosazná
	<a href="#">PR357-0006X</a>		PRIMA I.® tryska Ø 2.5 konická měděná
	<a href="#">PR357-0007X</a>		PRIMA I.® tryska Ø 3.0 konická měděná
	<a href="#">PR357-0002CPX</a>		PRIMA I.® tryska Ø 1.0 chrom
	<a href="#">PR357-0003CPX</a>		PRIMA I.® tryska Ø 1.2 chrom
	<a href="#">PR357-331CCPX</a>	<a href="#">485.73.431</a>	PRIMA I.® tryska Ø 1.5 chrom
	<a href="#">PR357-0004CPX</a>		PRIMA I.® tryska Ø 1.7 chrom
	<a href="#">PR357-322CCPX</a>	<a href="#">485.73.433</a>	PRIMA I.® tryska Ø 2.0 chrom
	<a href="#">PR357-0006CPX</a>		PRIMA I.® tryska Ø 2.5 chrom
	<a href="#">PR357-0007CPX</a>	<a href="#">485.73.43x</a>	PRIMA I.® tryska Ø 3.0 chrom
	<a href="#">PR395-0001</a>	<a href="#">480.73.107</a>	PRIMA I.® ochranný plastový kroužek pro hlavu 5"
	<a href="#">PR395-0002</a>		PRIMA I.® ochranný plastový kroužek pro hlavu 7,5"

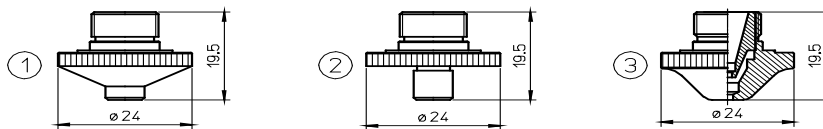

POS	obj.číslo	originál kód	popis
1	PR351-1E109		PRIMA I.® tryska Ø 0.8
	PR351-1E110		PRIMA I.® tryska Ø 1.0
	PR351-1E108		PRIMA I.® tryska Ø 1.2
	PR351-1E111	LW6.1E.111	PRIMA I.® tryska Ø 1.5
	PR351-1E112	LW6.1E.112	PRIMA I.® tryska Ø 2.0
	PR351-1E113	LW6.1E.113	PRIMA I.® tryska Ø 2.5
	PR351-1E114	LW6.1E.114	PRIMA I.® tryska Ø 3.0
	PR351-1E110CP		PRIMA I.® tryska Ø 1.0 chrom
	PR351-1E115CP		PRIMA I.® tryska Ø 1.2 chrom
	PR351-1E111CP	LW6.1E.111	PRIMA I.® tryska Ø 1.5 chrom
	PR351-1E112CP	LW6.1E.112	PRIMA I.® tryska Ø 2.0 chrom
	PR351-1E113CP	LW6.1E.113	PRIMA I.® tryska Ø 2.5 chrom
	PR351-1E114CP	LW6.1E.114	PRIMA I.® tryska Ø 3.0 chrom
	2	PR366-1G600	LW6.1G.500-LW6.1G.600
PR366-1G601		LW6.1G.501-LW6.1G.601	PRIMA I.® tryska Ø 2.0
PR366-1G602		LW6.1G.502-LW6.1G.602	PRIMA I.® tryska Ø 2.5
PR366-1G603		LW6.1G.503-LW6.1G.603	PRIMA I.® tryska Ø 3.0
PR366-1G601CP		LW6.1G.501-LW6.1G.601	PRIMA I.® tryska Ø 2.0 chrom
PR366-1G602CP		LW6.1G.502-LW6.1G.602	PRIMA I.® tryska Ø 2.5 chrom
PR366-1G603CP		LW6.1G.503-LW6.1G.603	PRIMA I.® tryska Ø 3.0 chrom
3	PR362-0008CP	1059.70000.010	PRIMA I.® dvojité tryska Ø 0.8 chrom
	PR362-0003CP	1059.70000.003	PRIMA I.® dvojité tryska Ø 1.0 chrom
	PR362-0002CP	1059.70000.008	PRIMA I.® dvojité tryska Ø 1.25 chrom
	PR362-0005CP	1059.70000.004	PRIMA I.® dvojité tryska Ø 1.5 chrom.
	PR362-0001CP	1059.70000.009	PRIMA I.® dvojité tryska Ø 1.75 chrom
	PR362-0004CP	1059.70000.005	PRIMA I.® dvojité tryska Ø 2.0 chrom
	PR362-0006CP	1059.70000.006	PRIMA I.® dvojité tryska Ø 2.5 chrom
	PR362-0007CP	1059.70000.007	PRIMA I.® dvojité tryska Ø 3.0 chrom

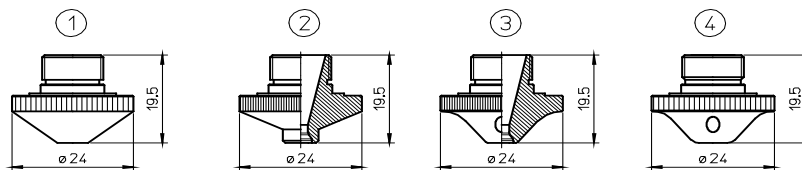

POS	obj.číslo	originál kód	popis
1	PR422-0001		PRIMA I.® tryska Ø 1.0
	PR422-0002		PRIMA I.® tryska Ø 1.5
	PR422-0003		PRIMA I.® tryska Ø 2.0
	PR422-0004		PRIMA I.® tryska Ø 2.5
	PR422-0005		PRIMA I.® tryska Ø 3.0
2	PR422-0650CP	LW6.1G.650	PRIMA I.® tryska Ø 3.0 chrom
3	PR422-0608CP	LW6. 1G. 608	PRIMA I.® tryska Ø 3.0 typ DL chrom
	PR422-0609CP	LW6. 1G. 609	PRIMA I.® tryska Ø 3.5 typ DL chrom
4	PR394-604	LW6. 1G. 604	PRIMA I.® tryska Ø 1.5 chrom
	PR394-603		PRIMA I.® tryska Ø 1.75 chrom
	PR394-605	LW6. 1G. 605	PRIMA I.® tryska Ø 2.0 chrom
	PR394-606	LW6. 1G. 606	PRIMA I.® tryska Ø 2.5 chrom
	PR394-607	LW6. 1G. 607	PRIMA I.® tryska Ø 3.0 chrom

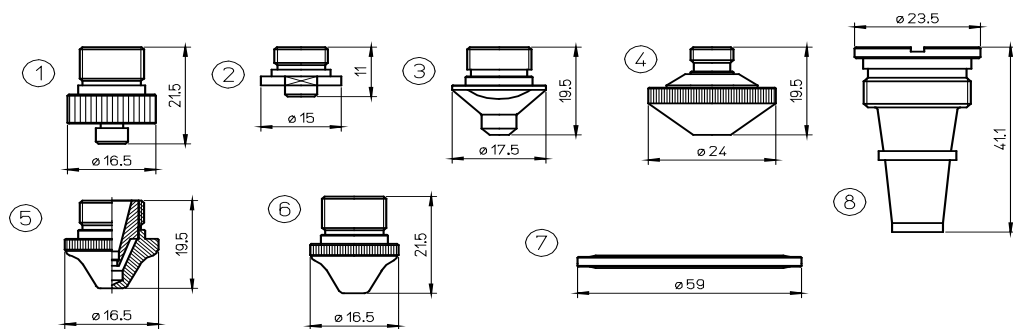

POS	obj.číslo	originál kód	popis
1	PR396-508	787.04.508	PRIMA I.® tryska Ø 1.5
	PR396-509	787.04.509	PRIMA I.® tryska Ø 2.0
	PR396-510	787.04.510	PRIMA I.® tryska Ø 2.5
	PR396-511	787.04.511	PRIMA I.® tryska Ø 3.0
2	PR397-0012		PRIMA I.® tryska Ø 1.2
	PR397-0001		PRIMA I.® tryska Ø 1.5
	PR397-0002		PRIMA I.® tryska Ø 2.0
	PR397-0003		PRIMA I.® tryska Ø 2.5
3	PR398-498	750.42.559	PRIMA I.® tryska Ø 0.3
	PR398-0001		PRIMA I.® tryska Ø 1.0
	PR398-550	750.42.550	PRIMA I.® tryska Ø 1.5
	PR398-551	750.42.551	PRIMA I.® tryska Ø 2.0
	PR398-552	750.42.552	PRIMA I.® tryska Ø 2.5
	PR398-0004	750.42.553	PRIMA I.® tryska Ø 3.0
	PR398-0001CP		PRIMA I.® tryska Ø 1.0 chrom
	PR398-0006	750.42.550	PRIMA I.® tryska Ø 1.5 chrom
	PR398-0002CP	750.42.551	PRIMA I.® tryska Ø 2.0 chrom
	PR398-0003CP	750.42.552	PRIMA I.® tryska Ø 2.5 chrom
PR398-0004CP	750.42.553	PRIMA I.® tryska Ø 3.0 chrom	
4	PR399-0001		PRIMA I.® L.W. tryska Ø 1.0
	PR399-0002		PRIMA I.® L.W. tryska Ø 1.5
	PR399-0003	LW3.1E.102	PRIMA I.® L.W. tryska Ø 2.0
	PR399-0004	LW3.1E.103	PRIMA I.® L.W. tryska Ø 2.5
	PR399-0005	LW3.1E.104	PRIMA I.® L.W. tryska Ø 3.0
5	PR421-111CP	520.17.111	PRIMA I.® dvojitá tryska Ø 1.5 chrom
	PR421-114CP	520.17.114	PRIMA I.® dvojitá tryska Ø 2.0 chrom
	PR421-560CP	750.43.560	PRIMA I.® dvojitá tryska Ø 2.5 chrom
	PR421-561CP	750.43.561	PRIMA I.® dvojitá tryska Ø 3.0 chrom
	PR421-562CP	750.43.562	PRIMA I.® dvojitá tryska Ø 3.5 chrom
6	PR409-4515	787.04.515	PRIMA I.® tryska Ø 1.25 chrom
	PR409-4512	787.04.512	PRIMA I.® tryska Ø 1.5 chrom
	PR409-4516	787.04.516	PRIMA I.® tryska Ø 1.75 chrom
	PR409-4513	787.04.513	PRIMA I.® tryska Ø 2.0 chrom
	PR409-4514	787.04.514	PRIMA I.® tryska Ø 2.5 chrom
7	PR421-720	1058.36520.720	PRIMA I.® těsnění pod čočku
8	PR422-1198		PRIMA I.® OPTIMO WELDING tryska měděná